

Part No:	GH-51151
Holding Capacity:	580Kg
Weight:	0.52Kg

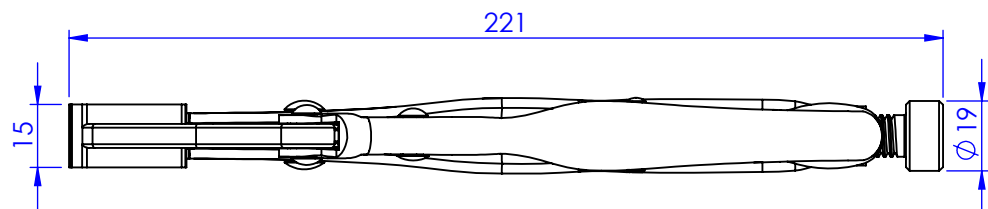
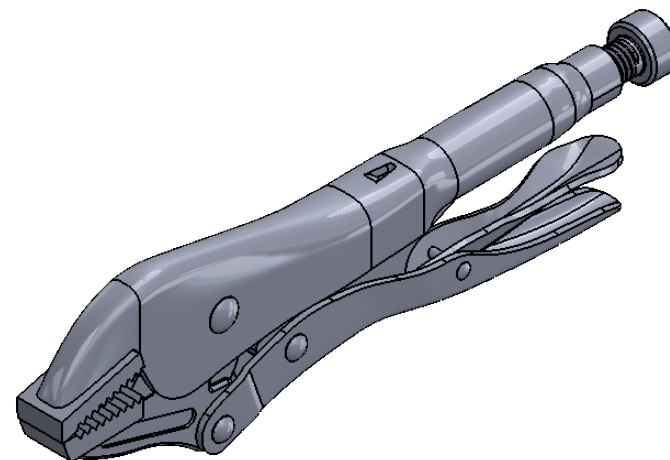
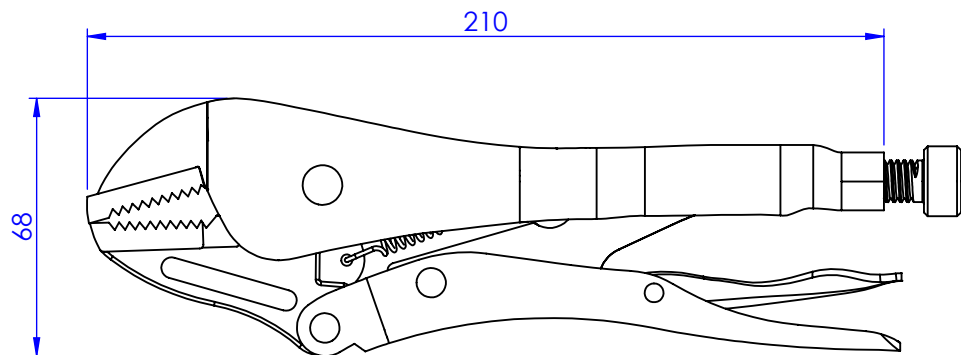

Unit:mm

Scale: 1:2

 **Good Hand Enterprise Co., Ltd**

TITLE:

DWG NO. GH-51151 A4