

Part No:	GH-51150
Holding Capacity:	350Kg
Weight:	0.34Kg

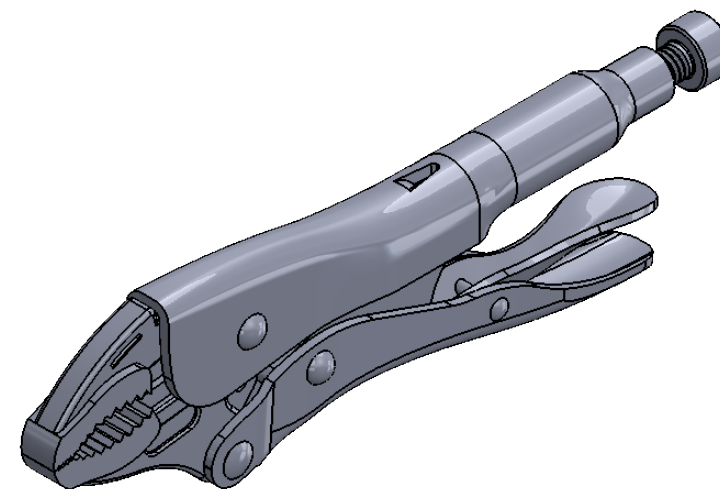
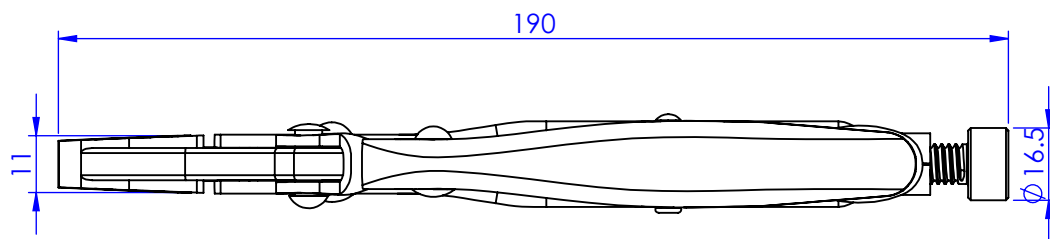
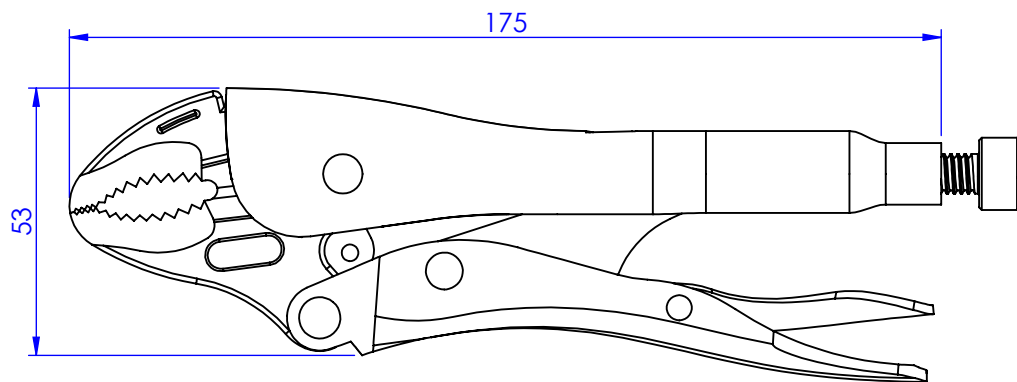

Unit:mm

Scale: 1:1.5

 **Good Hand Enterprise Co., Ltd**

TITLE:

DWG NO. GH-51150 A4