

Part No:	GH-51111
Holding Capacity:	350Kg
Weight:	0.85Kg

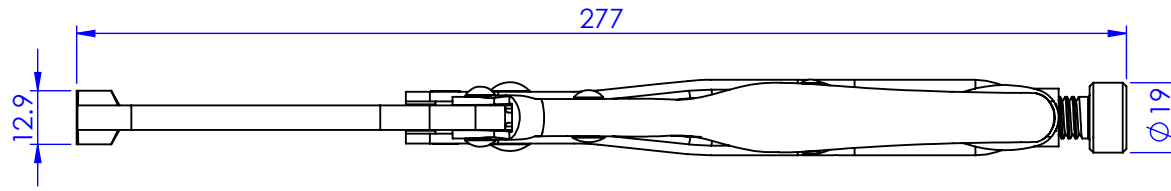
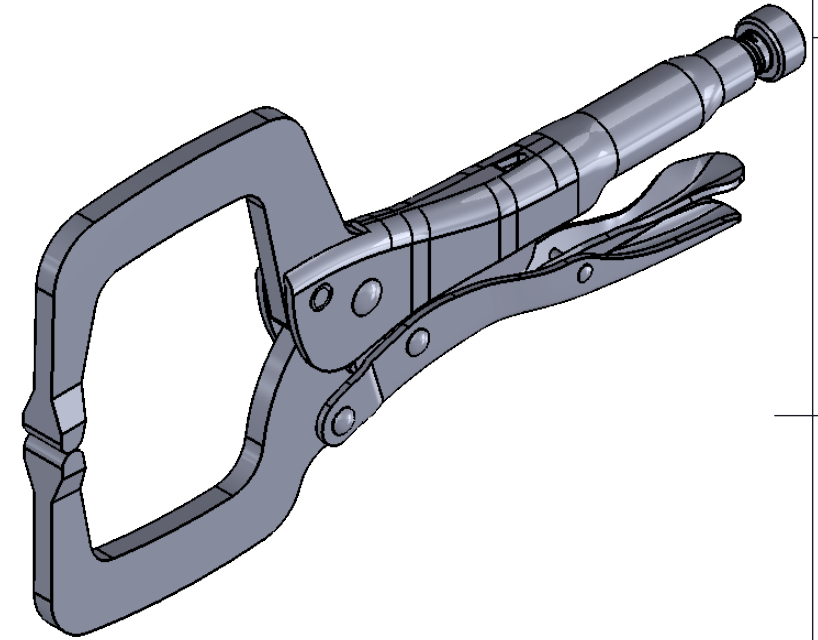
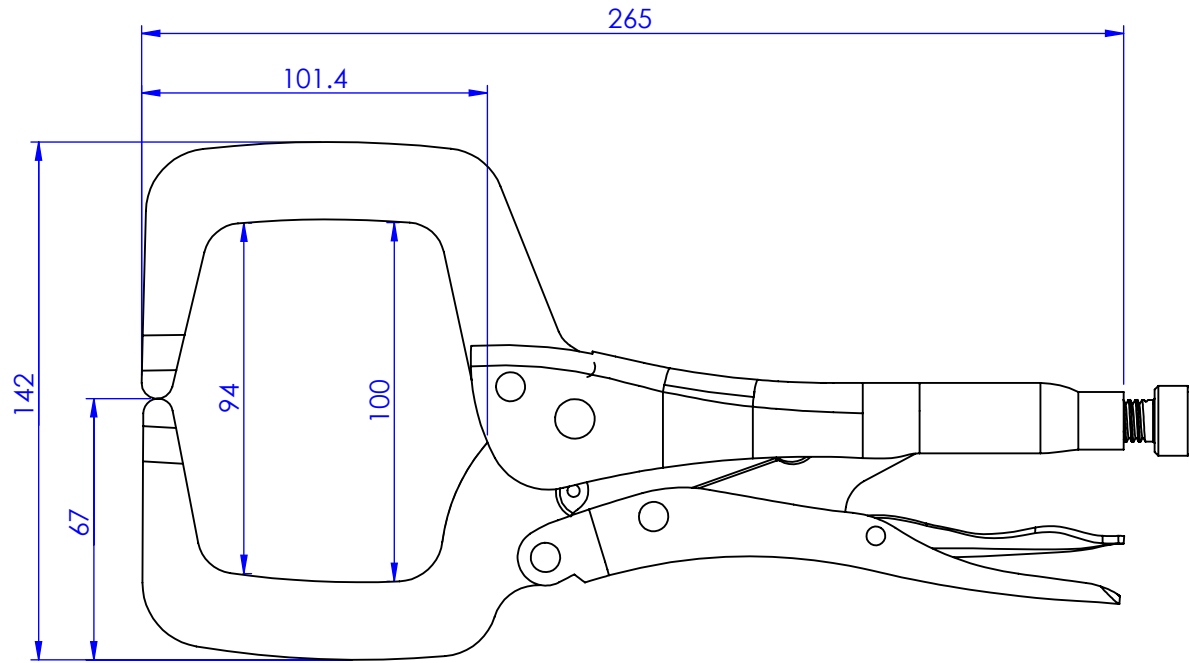

Unit:mm

Scale: 1:2

 **Good Hand Enterprise Co., Ltd**

TITLE:		
DWG NO.	GH-51111	A4