

Part No:	GH-51030
Holding Capacity:	260Kg
Weight:	0.86Kg

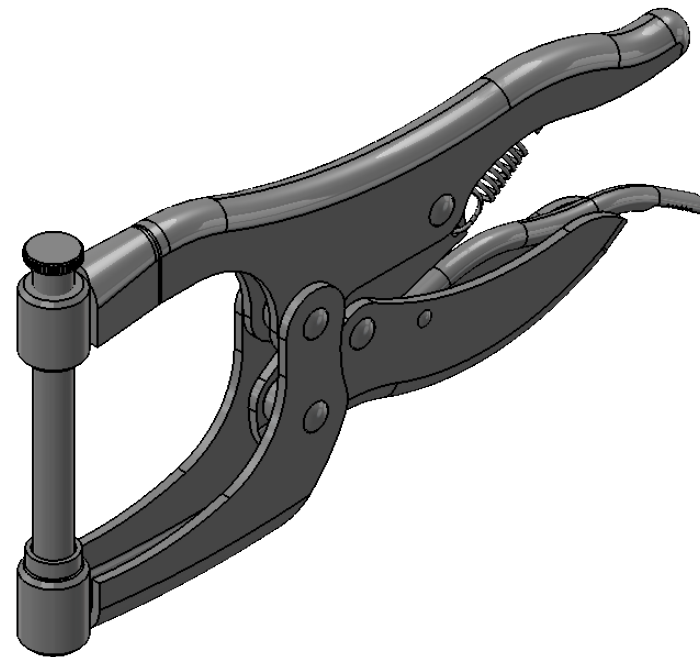
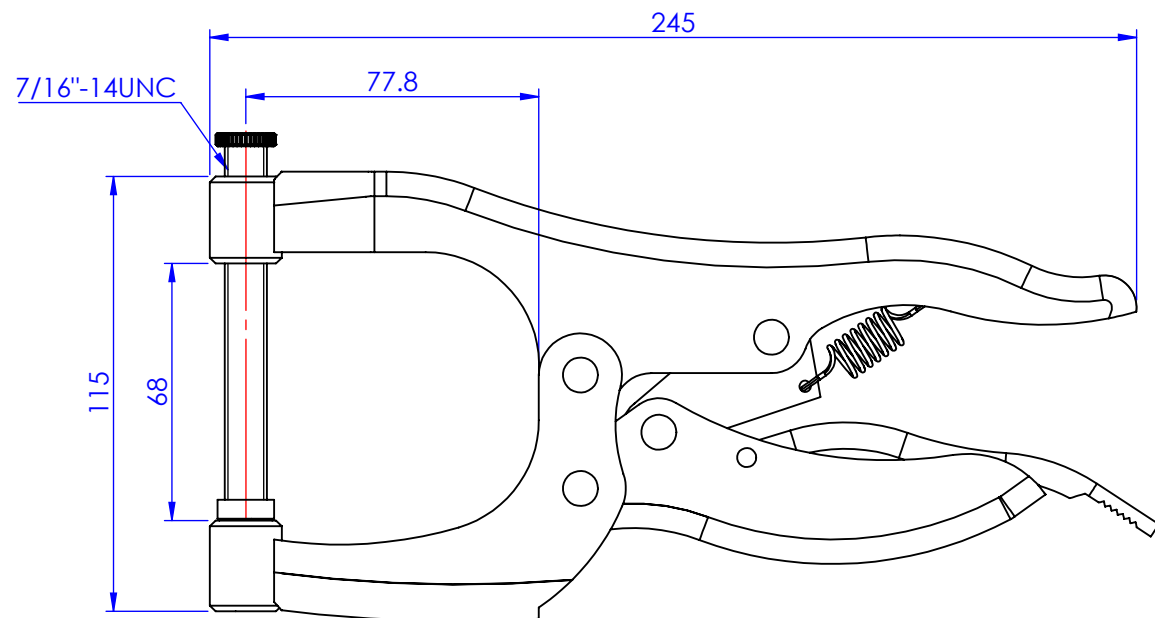
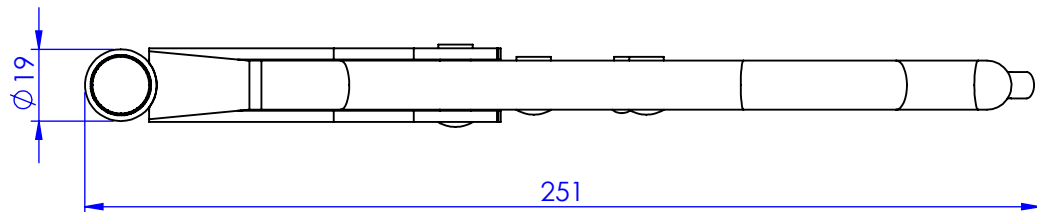

Unit:mm

Scale: 1:2

 **Good Hand Enterprise Co., Ltd**

TITLE:

DWG NO. GH-51030 A4