

Part No:	GH-51010
Holding Capacity:	250Kg
Weight:	0.48Kg
Spindle Supplied:	SA-56112

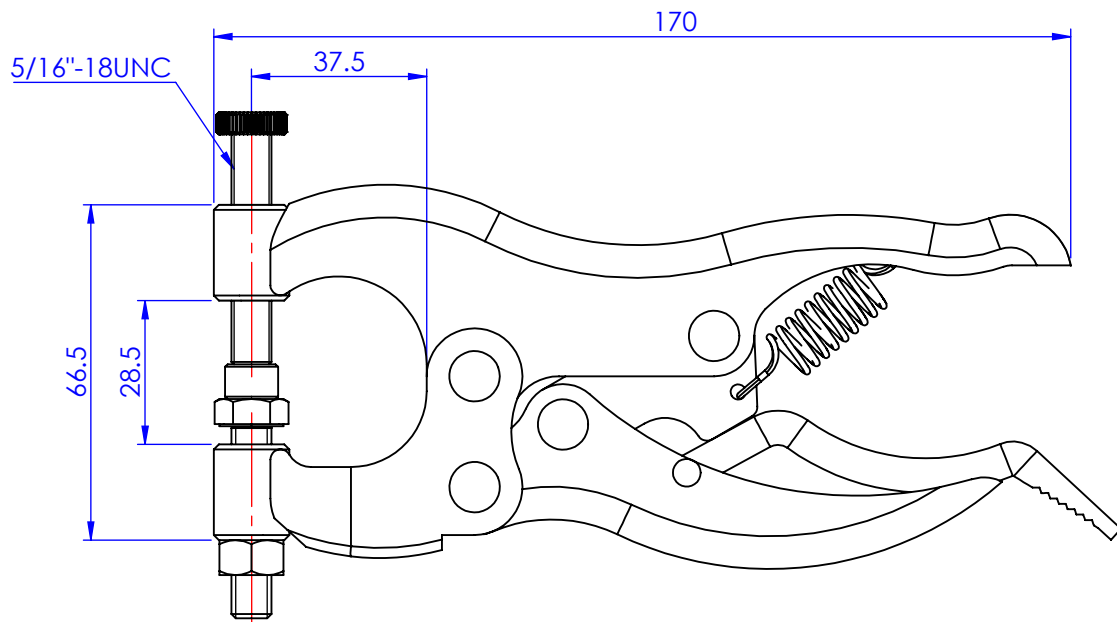
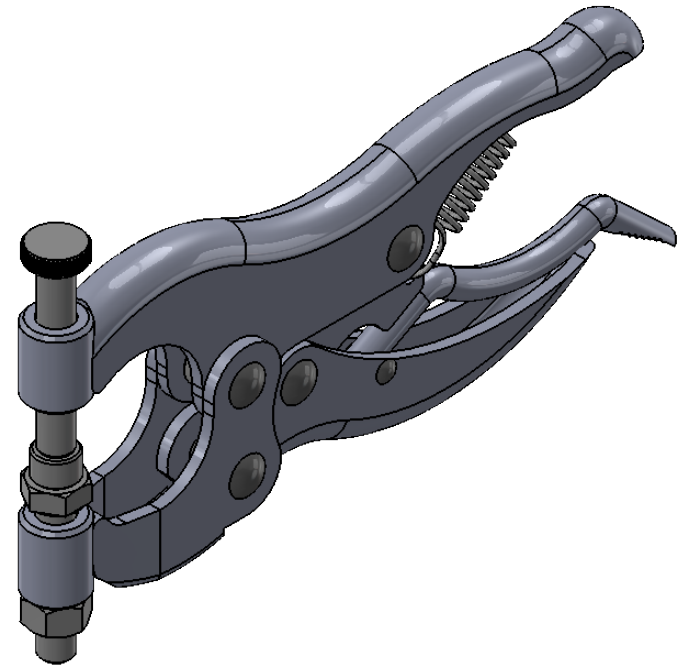
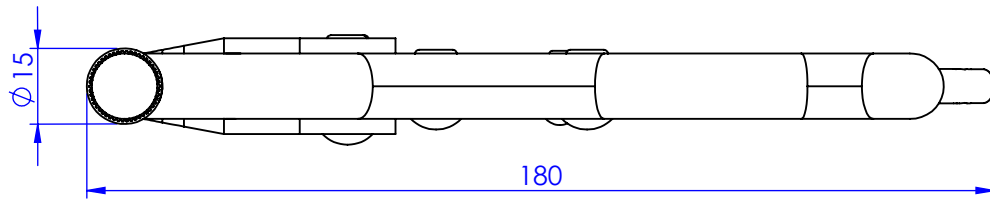

Unit:mm

Scale: 1:1.5

 **Good Hand Enterprise Co., Ltd**

TITLE:

DWG NO. GH-51010 A4