

Part No:	GH-51000
Holding Capacity:	200Kg
Weight:	0.27Kg
Spindle Supplied:	SA-56112

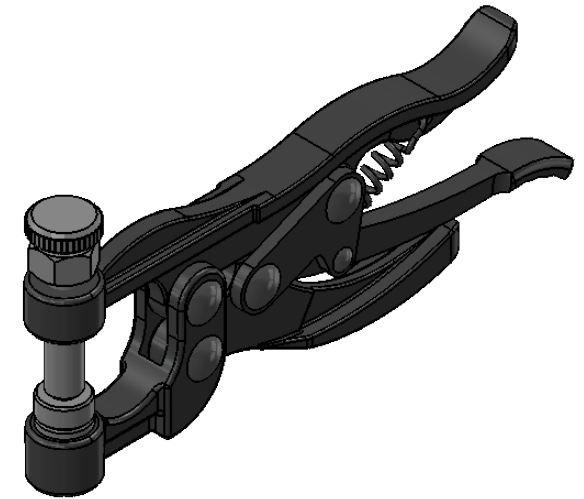
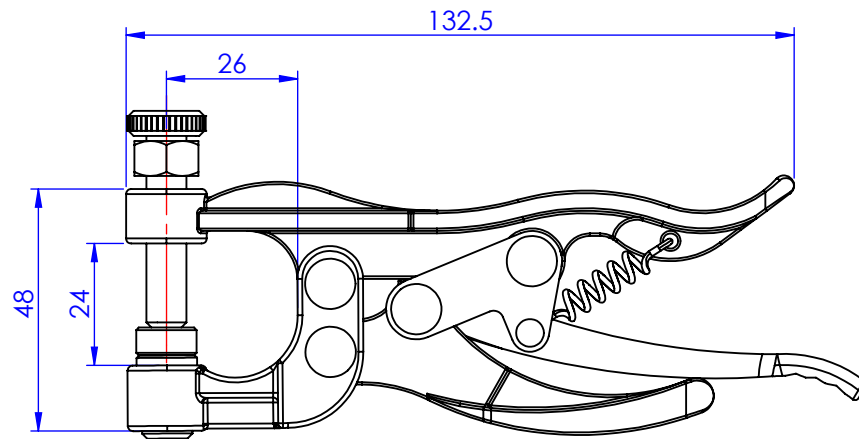
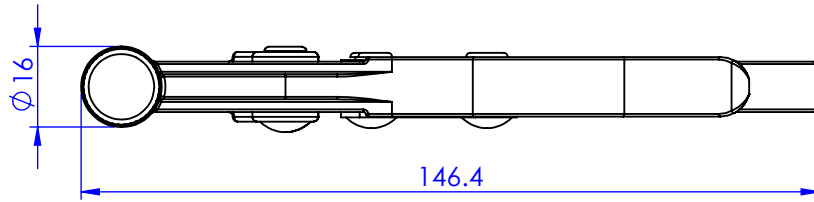

Unit:mm

Scale: 1:1.5

 **Good Hand Enterprise Co., Ltd**

TITLE:

DWG NO. GH-51000 A4