

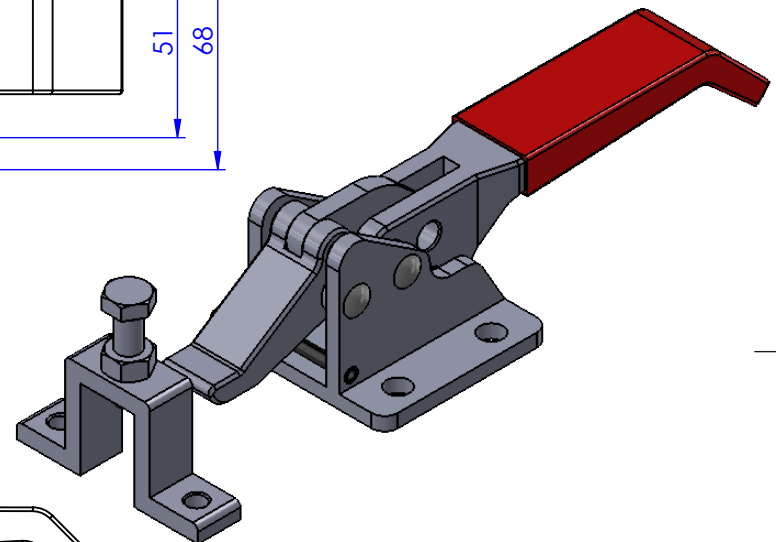

Part No:	GH-40580
Holding Capacity:	226Kg
Weight:	1.01Kg
Latch Plate Supplied:	GH-40580-LP

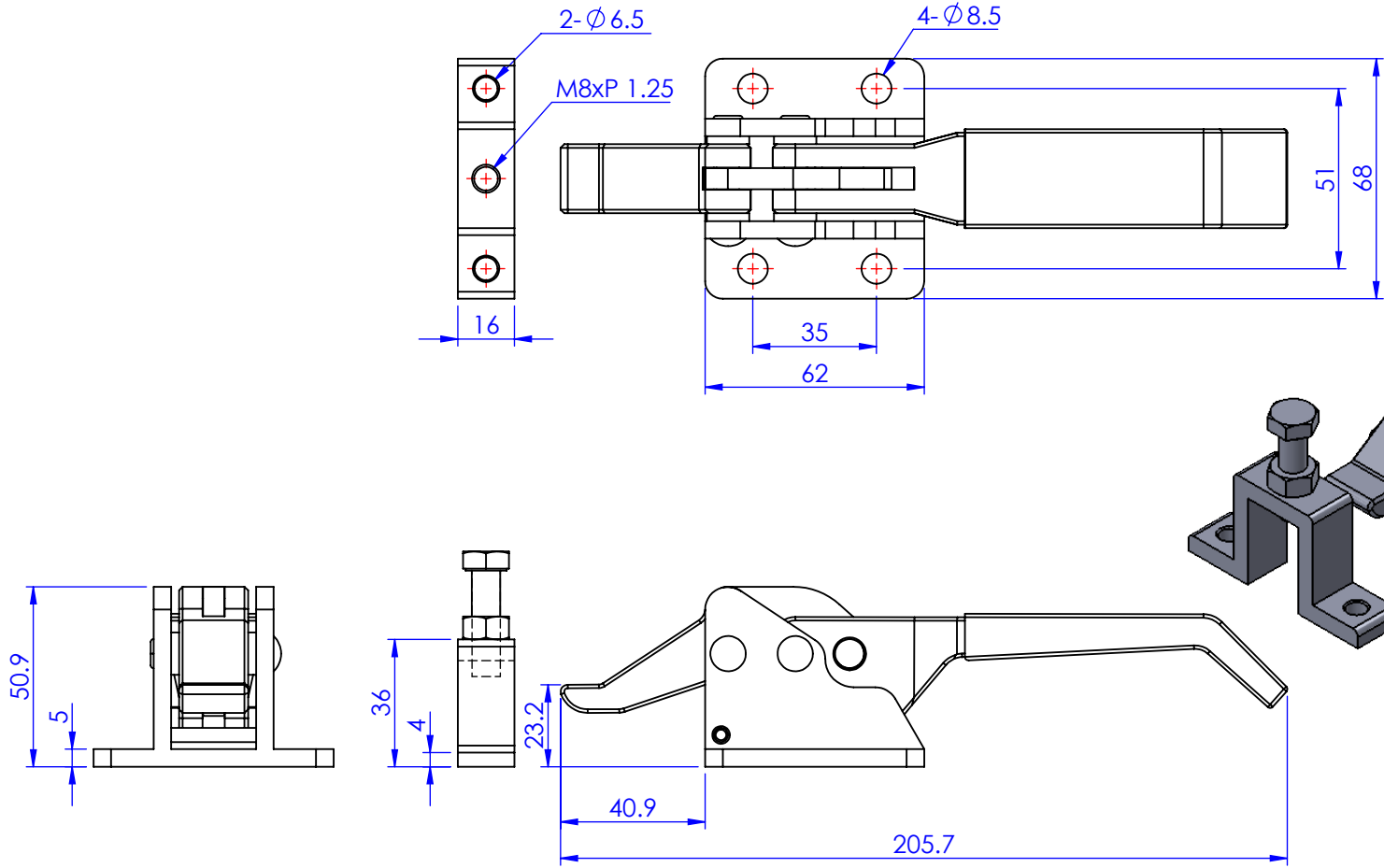

Unit:mm
Scale: 1:2

 Good Hand Enterprise Co., Ltd	
TITLE:	
DWG NO.	GH-40580
	A4