

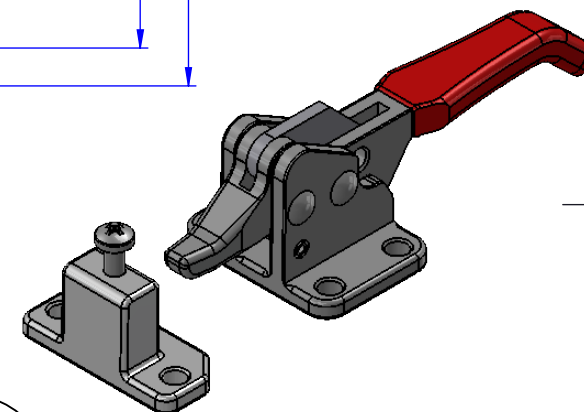

Part No:	GH-40550
Holding Capacity:	142Kg
Weight:	0.27Kg
Latch Plate Supplied:	GH-40550-LP

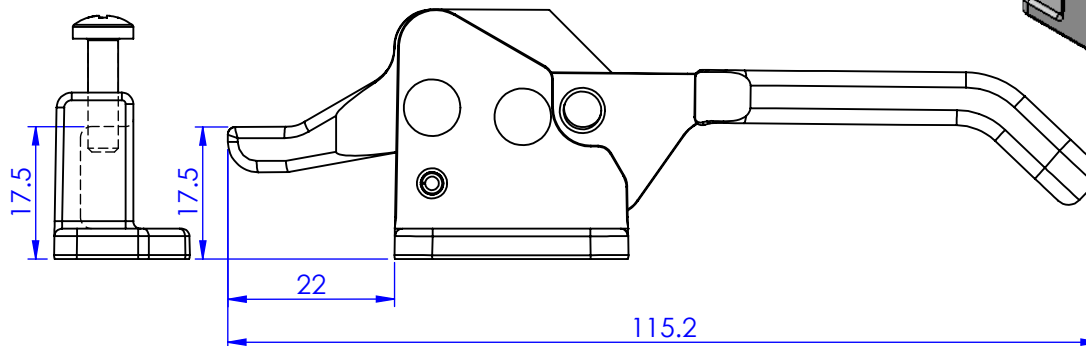
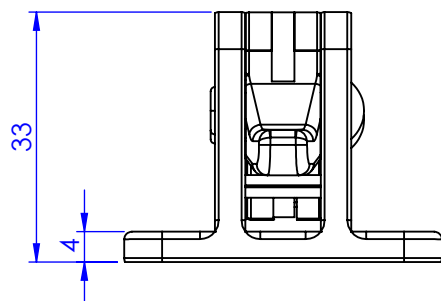
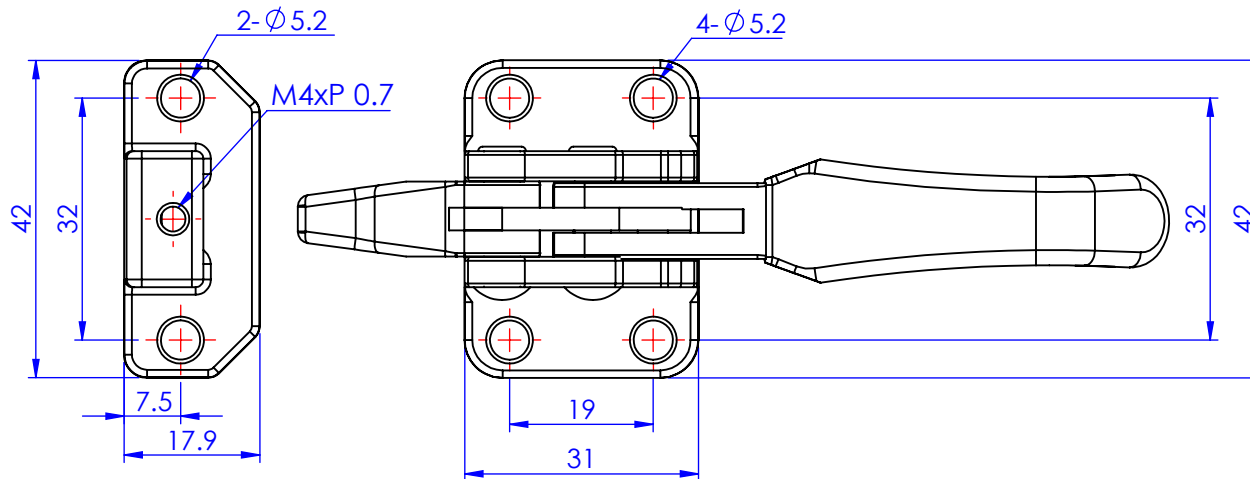

Unit:mm
Scale: 1:1

 Good Hand Enterprise Co., Ltd	
TITLE:	
DWG NO.	GH-40550
	A4