

Part No:	GH-40323
Holding Capacity:	163Kg
Weight:	0.07Kg
Latch Plate Supplied:	GH-40323-LP

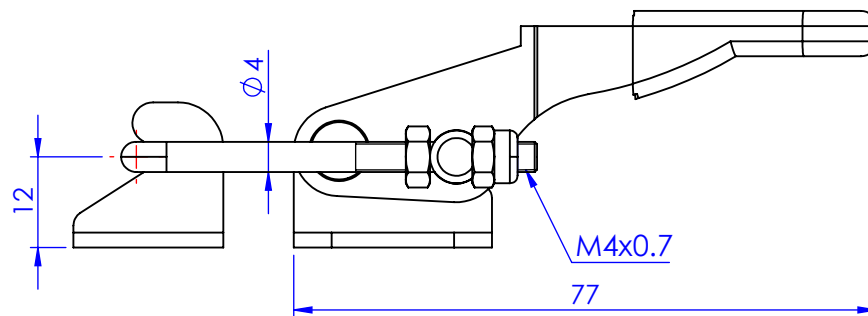
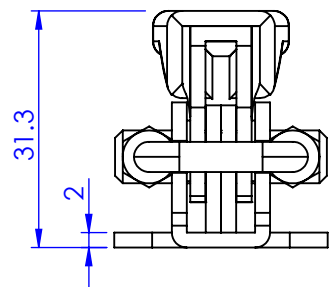
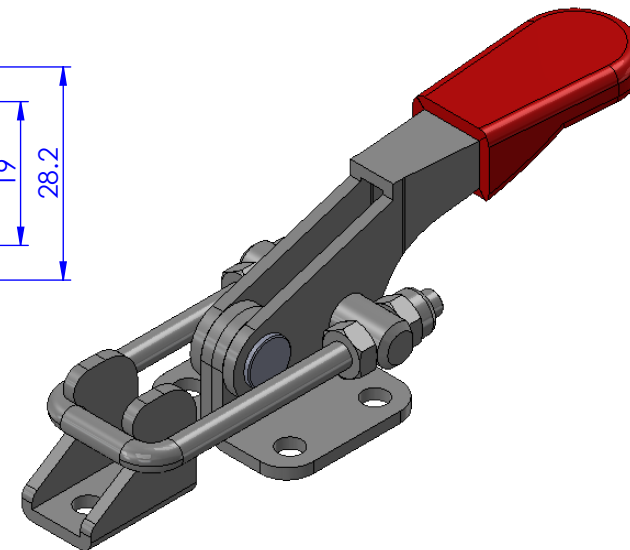
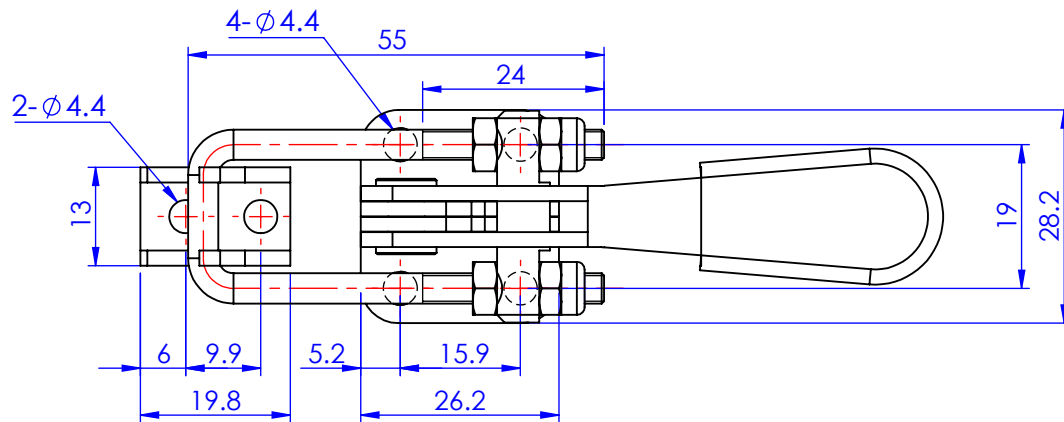

Unit:mm

Scale: 1:1

 **Good Hand Enterprise Co., Ltd**

TITLE:

DWG NO. GH-40323 A4