

Part No:	GH-30519M
Holding Capacity:	1136Kg
Plunger Stroke:	59.5 mm
Handle Opens:	183°
Weight:	1.69Kg
Spindle Supplied:	SA-125017

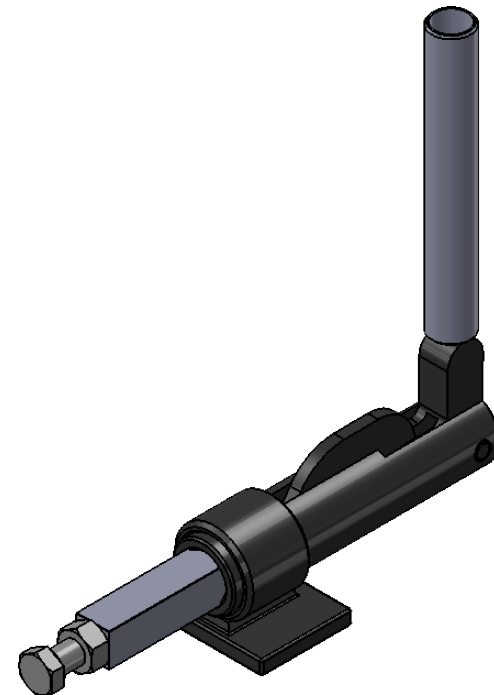

Unit:mm
Scale: 1:3

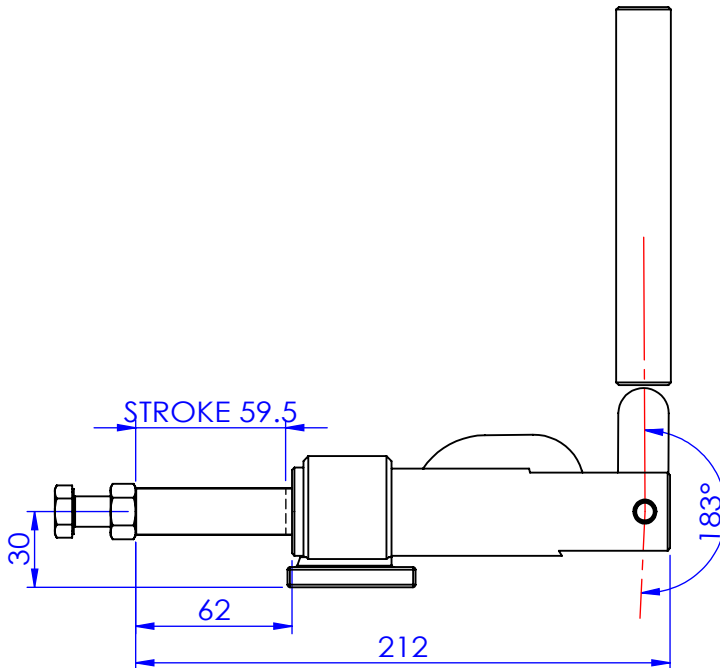
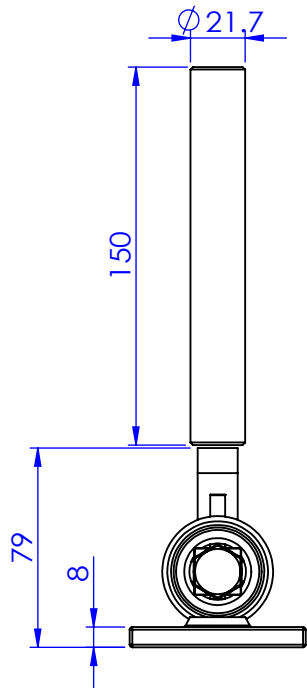
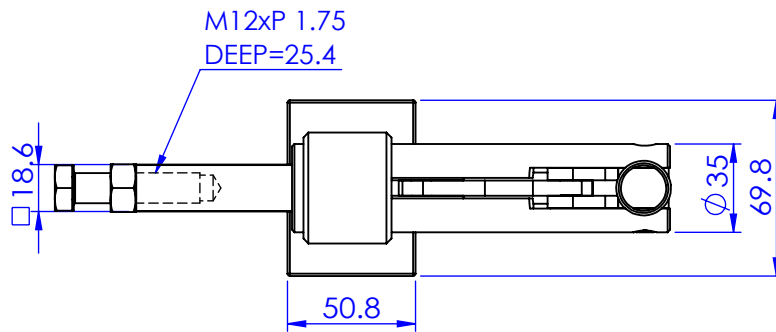

Good Hand Enterprise Co., Ltd

TITLE:		
DWG NO.	GH-30519M	A4