

Part No:	GH-201-B
Holding Capacity:	90Kg
Bar Opens:	85°
Handle Opens:	73°
Weight:	0.13Kg
Spindle Supplied:	FC-064410
Flanged Washers:	FW-140

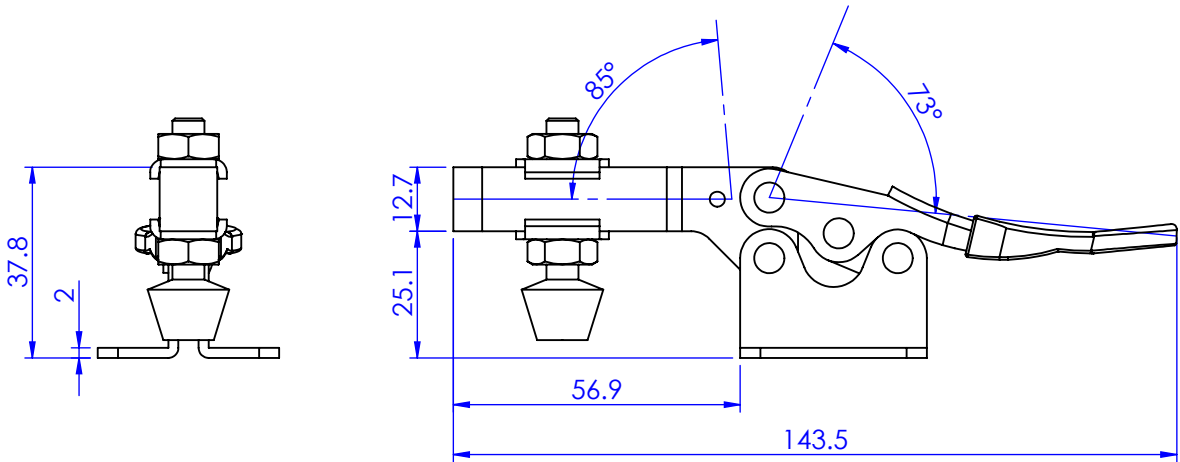
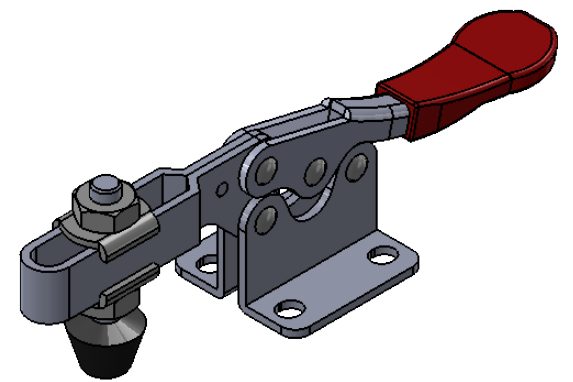
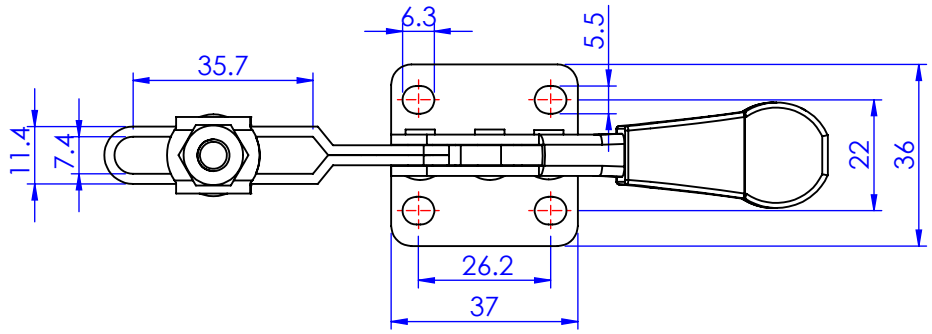

Unit:mm
Scale: 1:1.5

 **Good Hand Enterprise Co., Ltd**

TITLE:

DWG NO. GH-201-B

A4