

Part No:	GH-13005-SS
Holding Capacity:	68Kg
Bar Opens:	90°
Handle Opens:	170°
Weight:	0.06Kg
Spindle Supplied:	SA-053008-SS
Flanged Washers:	FW-100-SS

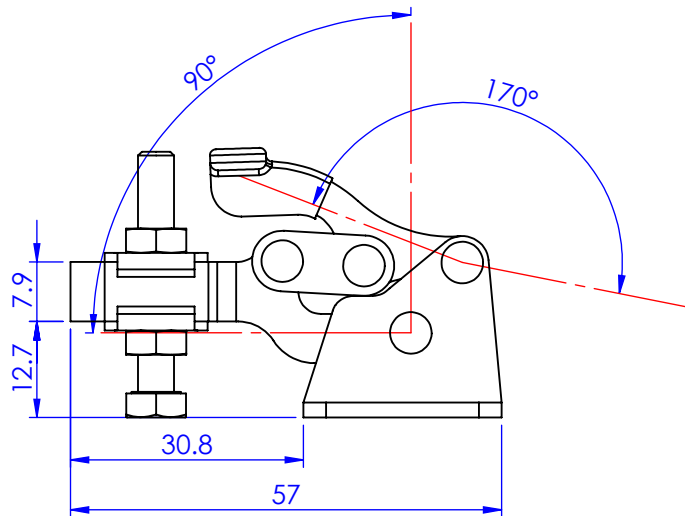
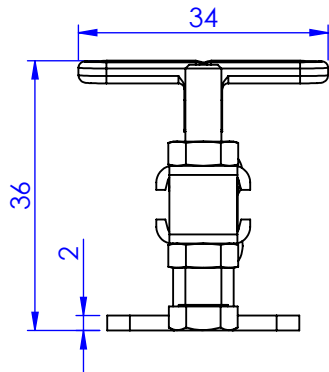
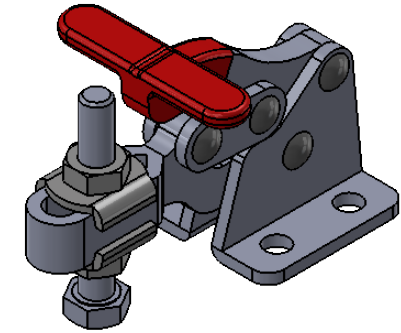
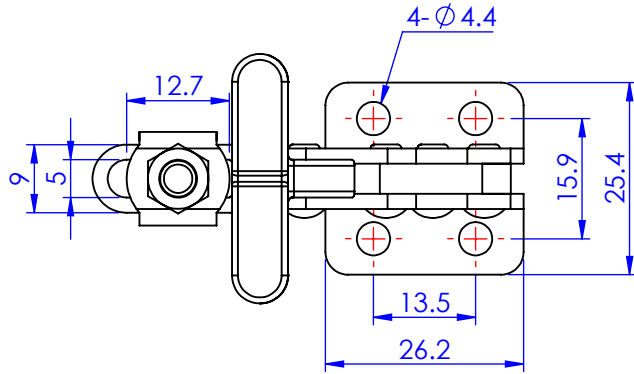

Unit:mm

Scale: 1:1

 **Good Hand Enterprise Co., Ltd**

TITLE:

DWG NO. GH-13005-SS A4